



**ACF**

VENTILATOREN



***Radialventilator  
Baureihe: VM***

# VM

VENTILATORE AD ALTO RENDIMENTO  
HIGH EFFICIENCY FAN



GIRANTE A PALE CURVE ROVESCE  
BACKWARD CURVED BLADES IMPELLER

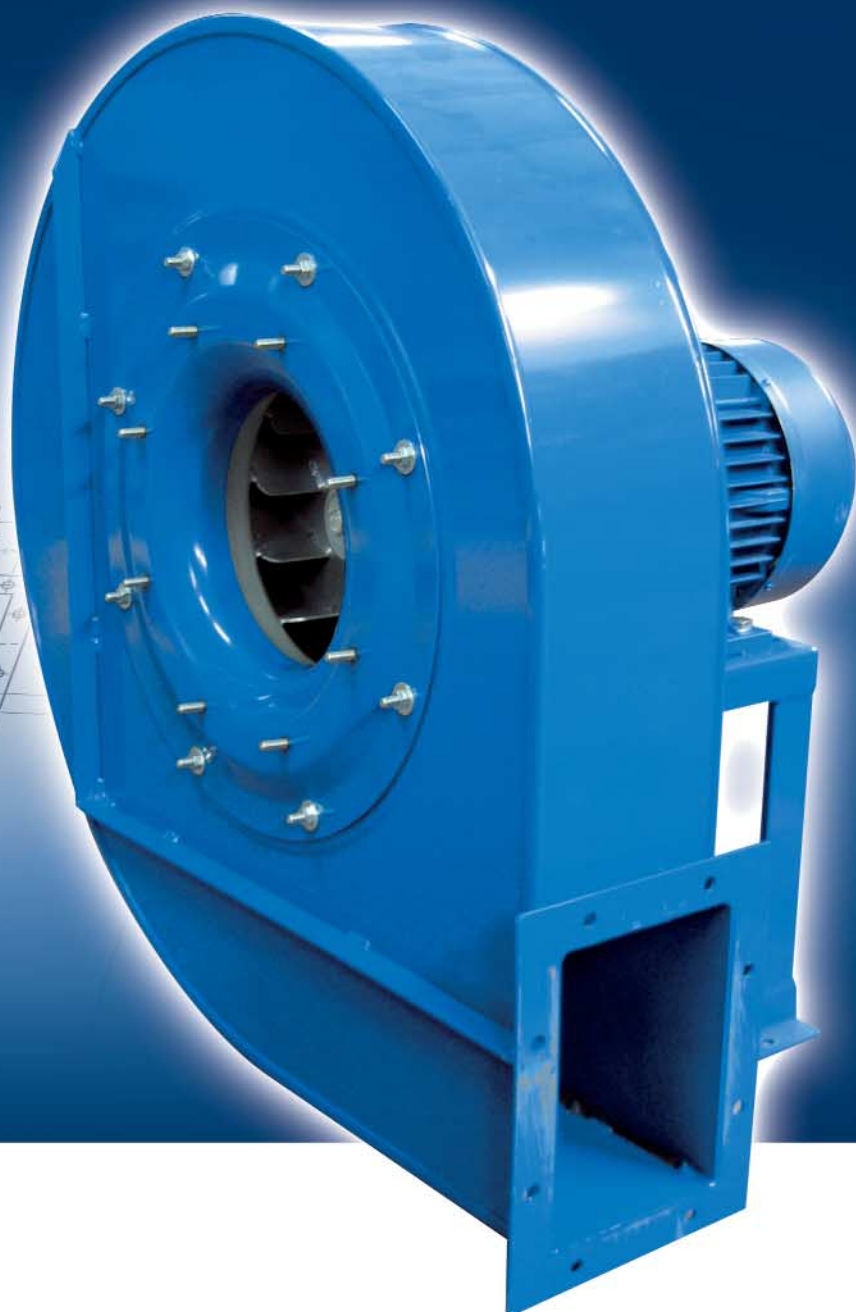

**ALTA PRESSIONE**  
HIGH PRESSURE

Portata/Flow rate:  
**300 ÷ 65000 m<sup>3</sup>/h**

Pressione/Pressure:  
**110 ÷ 2200 mm H<sub>2</sub>O**



**ACF**



**Ihr Partner für Ventilatoren**  
Stahl | Edelstahl | Aluminium Kunststoff

# VM

## VENTILATORE AD ALTO RENDIMENTO HIGH EFFICIENCY FAN



### **Ventilatore ad alto rendimento: Mod. VM.**

Campo di lavoro: portate piccole e medie, prevalenze alte.

Tipo di pale: rovesce.

Applicazioni: per trasporto pneumatico, fumi, polveri fini.

Adatto al trasporto di materiali solidi in miscela con aria, trucioli e segatura, con ventilatore non attraversato.

Temperatura del fluido: fino a 60° C in esecuzione standard; esecuzioni speciali per temperature superiori.

Caratteristiche costruttive: ventilatore di costruzione particolarmente robusta eseguito in lamiera verniciata, ventola in acciaio equilibrata staticamente e dinamicamente.

Caratteristiche di funzionamento: condizioni dell'aria in aspirazione  $T = 15^{\circ} \text{C}$ ,  $p = 1 \text{ atm}$ .

### **High efficiency fan: Mod. VM.**

*Field of application: medium and low capacities, high pressures.*

*Type of blades: backward.*

*Applications: for the pneumatic conveyance, gasses, granulated materials. Suitable for the transport of solid materials mixed with air, sawdust and woodchips if the fan is not crossed.*

*Air temperature: up to 60° C standard, special features for higher temperatures.*

*Construction specifications: rigid construction in sheet metal.*

*Statically and dynamically balanced impellers.*

*Working principles: condition of the ducted air  $T = 15^{\circ} \text{C}$ ,  $p = 1 \text{ atm}$ .*



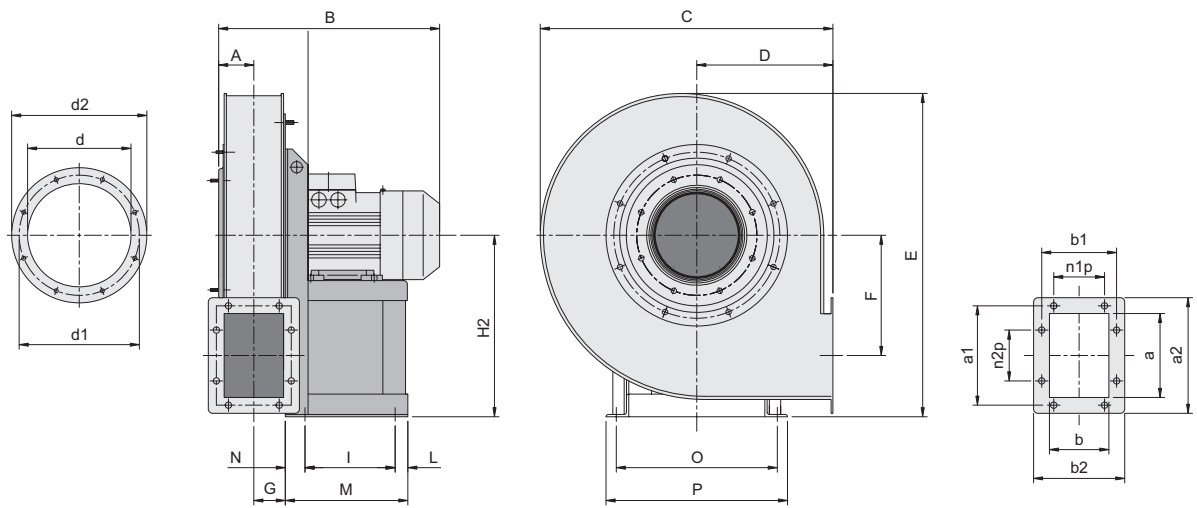

**Orientamento RD 270**  
Position RD 270

**Direzioni di rotazione (vista lato motore) - Rotation senses (seen from motor side)**

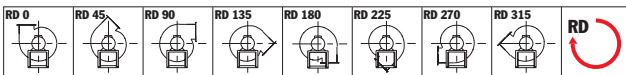

**Rotazione oraria - Clockwise rotation sense**

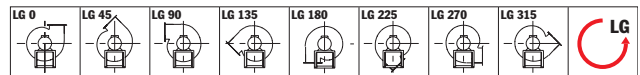

**Rotazione anti-oraria - Anti-Clockwise rotation sense**

# DIMENSIONI D'INGOMBRO

## OVERALL DIMENSIONS



TIPO - TYPE		PESO WEIGHT	PD² GD²	VENTILATORE FAN									
VENTILATORE FAN	MOTORE MOTOR			kgf	kgf m²	A	B	C	D	E	F	G	H
VM 350/NR VM 350/N	80 A2 80 B2	32 36	0,3 0,34	65	370	535	250	615	215	56	355	250	355
VM 400/NR VM 400/N	90 S2 90 L2	48 52	0,6 0,7	71	425	590	280	658	238	63	375	280	375
VM 450/NR VM 450/N	100 LA2 112 M2	63 78	1 1,2	78	510	645	300	715	265	70	400	300	400
VM 500/NR VM 500/N	112 M2 132 SA2	93 106	1,3 1,6	86	525 585	715	335	795	297	78	450	335	450
VM 560/NR VM 560/N	132 SB2 160 MA2	133 141	2 2,6	95	605 740	805	375	890	337	89	500	375	500
VM 630/NR VM 630/N	160 MB2 160 L2	193 206	3,4 4,1	105	760	910	425	1000	381	99	560	425	560
VM 711/NR VM 711/N VM 712/NR VM 712/N	180 M2 200 LA2 112 M4 132 SA4	276 396 186 196	6,8 7,7 6,8 7,7	115	785 860 585 650	1015	475	1122	426	108	630	475	630
VM 801/NR VM 801/N VM 802/NR VM 802/N	200 LB2 250 M2 132 MA4 132 MB4	436 550 286 291	10 13 10 13	127	885 960 675 675	1140	530	1265	481	122	710	530	710
VM 901/NR VM 901/N VM 902/NR VM 902/N	280 S2 280 M2 160 M4 160 L4	802 841 456 466	21 26 21 26	140	1115 1115 835 835	1285	600	1428	542	136	800	600	800
VM 1001/NR VM 1001/N VM 1002/NR VM 1002/N	315 S2 315 MC2 180 M4 180 L4	1085 1115 586 626	34 40 34 40	160	1150 1290 870 945	1430	670	1590	607	152	900	670	900

VM 350 ÷ 1000

**Peso ventilatore in Kgf (completo di motore)**  
 Weight of ventilator (complete with motor)  
**NOTA: quota B indicativa**  
 NOTE: "B" quote indicative

TIPO - TYPE	FLANGIA ASPIRANTE INLET FLANGE					FLANGIA PREMENTE OUTLET FLANGE										BASAMENTO BASE														
	VENTILATORE FAN	d	d <sub>1</sub>	d <sub>2</sub>	n°	∅	a	b	a <sub>1</sub>	b <sub>1</sub>	a <sub>2</sub>	b <sub>2</sub>	n.xp	n.xp	n°	∅	I	J	K	L	M	N	O	P	Q	R	S	T	U	∅
VM 350/NR VM350/N	185	219	250	8	8	146	105	182	139	216	175	-	1x112	6	12	121	-	-	45	211	45	203	225	-	-	-	-	-	-	10
VM 400/NR VM 400/N	205	241	275	8	8	166	117	200	151	236	187	-	1x112	6	12	133	-	-	58	246	55	234	260	-	-	-	-	-	-	10
VM 450/NR VM 450/N	228	265	298	8	8	185	131	219	165	255	201	-	1x112	6	12	197	-	-	49	276	30	289	324	-	-	-	-	-	-	12
VM 500/NR VM 500/N	255	292	325	8	10	207	148	241	182	277	218	1x112	1x112	8	12	197 237	-	-	49 59	276 336	30 40	289 337	324 372	-	-	-	-	-	-	12
VM 560/NR VM 560/N	285	332	365	8	10	231	166	265	200	301	236	1x112	1x112	8	12	237 337	-	-	59 49	336 436	40 50	337 395	372 440	-	-	-	-	-	-	14
VM 630/NR VM 630/N	320	366	400	8	10	258	185	292	219	328	255	1x112	2x112	10	12	337	-	-	49	436	50	395	440	-	-	-	-	-	-	14
VM 711/NR VM 711/N VM 712/NR VM 712/N	360	405	440	8	10	288	205	332	249	368	285	1x125	2x125	10	12	357 381 197 237	-	-	33 39 49 59	460 500 276 336	70 80 30 40	434 506 289 337	488 568 324 372	-	-	-	-	-	-	17
VM 801/NR VM 801/N VM 802/NR VM 802/N	405	448	485	12	10	322	229	366	273	402	309	1x125	2x125	10	12	381 501 237 237	-	-	39 39 59 59	500 600 336 336	80 60 40 40	506 604 337 372	568 690 372 372	-	-	-	-	-	-	19
VM 901/NR VM 901/N VM 902/NR VM 902/N	455	497	535	12	10	361	256	405	300	441	336	1x125	2x125	10	12	591 591 337 337	-	-	39 39 49 49	690 690 436 436	60 60 50 50	690 690 395 395	750 750 440 440	-	-	-	-	-	-	21
VM 1001/NR VM 1001/N VM 1002/NR VM 1002/N	505	551	585	12	10	404	288	448	332	484	368	2x125	3x125	14	12	675 675 357 357	-	-	45 45 33 33	800 800 460 460	80 80 70 70	760 760 434 488	865 865 488 488	-	-	-	-	-	-	24

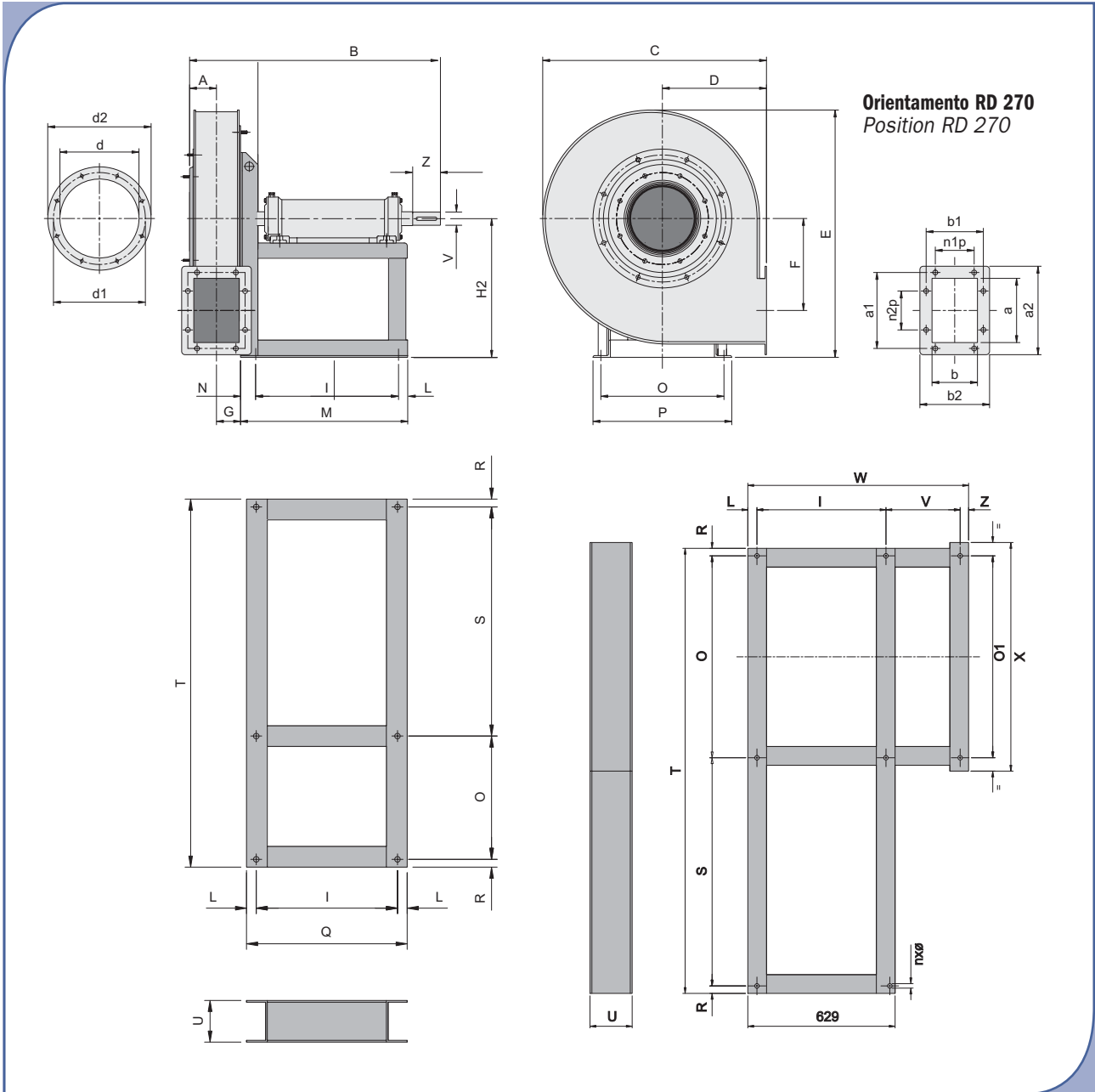

**Orientamento RD 270**  
Position RD 270

**Direzioni di rotazione (vista lato motore) - Rotation senses (seen from motor side)**

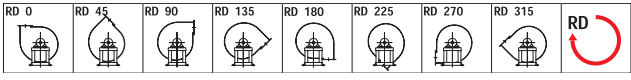

**Rotazione oraria - Clockwise rotation sense**

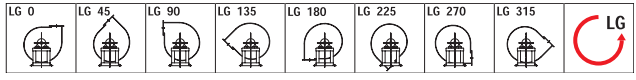

**Rotazione anti-oraria - Anti-Clockwise rotation sense**

# DIMENSIONI D'INGOMBRO

## OVERALL DIMENSIONS



# VM/T 350÷1250

Peso ventilatore in Kgf (completo di motore) - Weight of ventilator (complete with motor)

Nota: Quota B indicativa - Note: B quote indicative

TIPO - TYPE VENTILATORE FAN	PESO WEIGHT kgf	PD <sup>2</sup> GD <sup>2</sup> kgf m <sup>2</sup>	VENTILATORE FAN											
			V	Z	A	B	C	D	E	F	G	H	H <sub>1</sub>	H <sub>2</sub>
VM 350/T	30	0,34	24	50	65	555	535	250	615	215	56	355	250	355
VM 400/T	54	0,70	28	60	71	710	590	280	658	238	63	375	280	375
VM 450/T	60	1,2	38	80	78	745	645	300	715	265	70	400	300	400
VM 500/T	82	1,5	38	80	86	765	715	335	795	297	78	450	335	450
VM 560/T	122	2,6	42	110	95	885	805	375	890	337	89	500	375	500
VM 630/T	173	4,1	48	110	105	905	910	425	1000	381	99	560	425	560
VM 710/T	220	7,7	48	110	115	1020	1015	475	1122	426	108	550	475	630
VM 800/T	290	13	55	110	127	1045	1140	530	1265	481	122	620	530	710
VM 900/T	469	26	65	140	140	1190	1285	600	1428	542	136	695	600	800
VM 1000/T	680	40	80	170	160	1445	1430	670	1590	607	152	770	670	900
VM 1120/T	710	61	80	170	185	1480	1600	750	1770	684	169	860	750	1000
VM 1250/T	770	97	90	170	200	1695	1785	840	1983	765	189	960	840	1120

TIPO - TYPE VENTILATORE FAN	FLANGIA ASPIRANTE INLET FLANGE					FLANGIA PREMENTE OUTLET FLANGE										BASAMENTO BASE													
	d	d <sub>1</sub>	d <sub>2</sub>	n°	∅	a	b	a <sub>1</sub>	b <sub>1</sub>	a <sub>2</sub>	b <sub>2</sub>	n <sub>1</sub> xp	n <sub>2</sub> xp	n°	∅	I	J	K	L	M	N	O	P	Q	R	S	T	U	∅
VG 350/T	185	219	250	8	8	146	105	182	139	216	175	-	1x112	6	12	284	-	-	23	347	40	288	324	330	18	576	900	100	12
VG 400/T	205	241	275	8	8	166	117	200	151	236	187	-	1x112	6	12	407	-	-	28	485	50	355	400	463	22,5	660	1060	120	14
VG 450/T	228	265	298	8	8	185	131	219	165	255	201	-	1x112	6	12	407	-	-	28	485	50	355	400	463	22,5	660	1060	120	14
VG 500/T	255	292	325	8	10	207	148	241	182	277	218	1x112	1x112	8	12	407	-	-	28	485	50	355	400	463	22,5	780	1180	120	14
VG 560/T	285	332	365	8	10	231	166	265	200	301	236	1x112	1x112	8	12	477	-	-	33	560	50	364	418	543	27	832	1250	160	17
VG 630/T	320	366	400	8	10	258	185	292	219	328	255	1x112	2x112	10	12	477	-	-	33	560	50	364	418	543	27	832	1250	160	17
VG 710/T	360	405	440	8	10	288	205	332	249	368	285	1x125	2x125	10	12	551	-	-	39	650	60	526	590	629	32	1040	1600	180	19
VG 800/T	405	448	485	12	10	322	229	366	273	402	309	1x125	2x125	10	12	551	-	-	39	650	60	526	590	629	32	1040	1600	180	19
VG 900/T	455	497	535	12	10	361	256	405	300	441	336	1x125	2x125	10	12	607	-	-	45	705	55	663	735	697	36	1065	1800	200	19
VG 1000/T	505	551	585	12	10	404	288	448	332	484	368	2x125	3x125	14	12	780	-	-	55	935	100	850	960	890	55	1240	2200	200	24
VG 1120/T	565	629	665	12	10	453	322	497	366	533	402	2x125	3x125	14	12	780	-	-	55	935	100	850	960	890	55	1240	2200	200	24
VG 1250/T	635	698	735	12	10	507	361	551	405	587	441	2x125	3x125	14	12	917	-	-	55	1102	120	940	1060	1047	60	1340	2400	200	28





# VM

PRESTAZIONI VENTILATORI A TRASMISSIONE  
BELT DRIVEN FANS PERFORMANCES

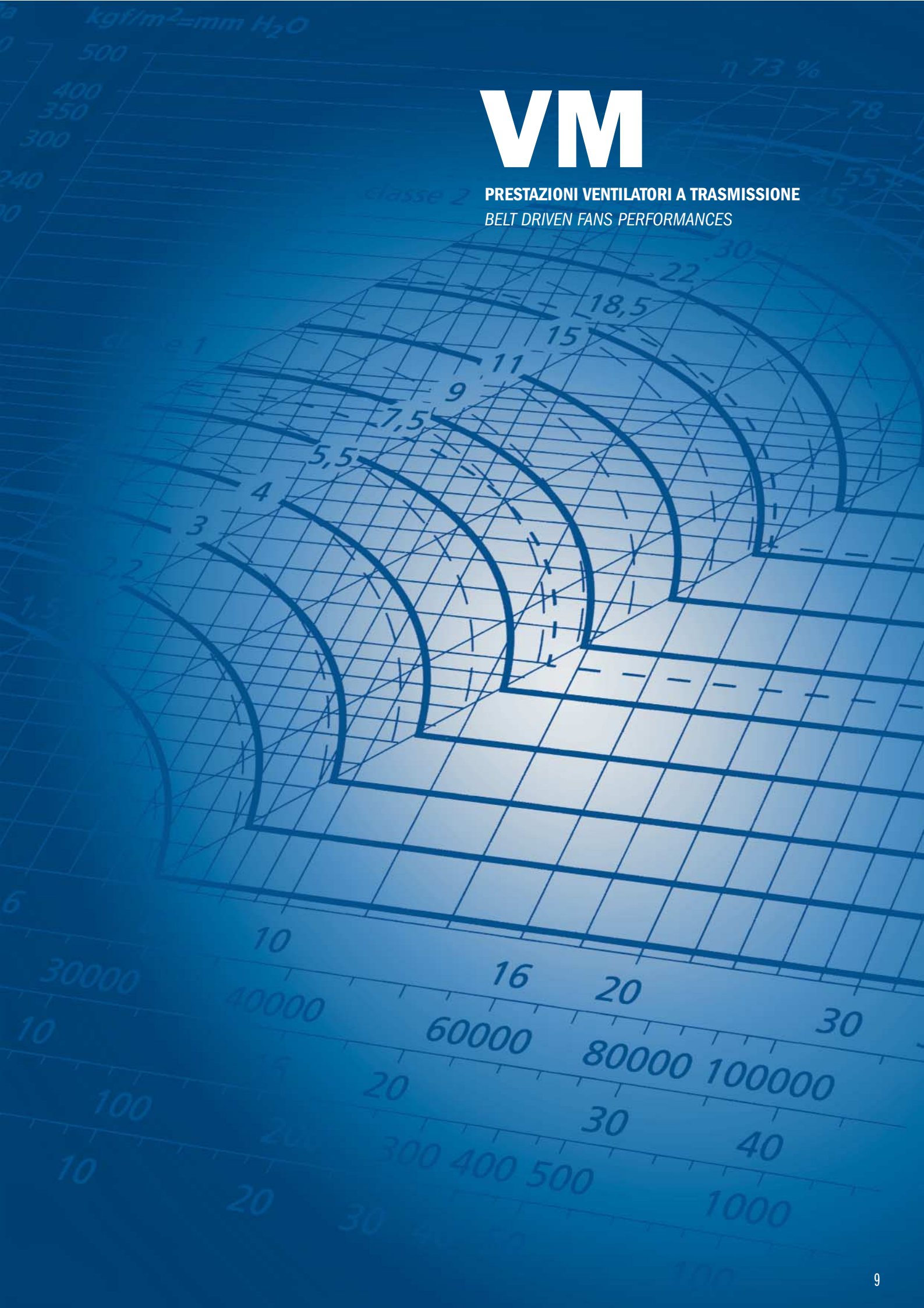



# PRESTAZIONI VENTILATORI A TRASMISSIONE

## BELT DRIVEN FANS PERFORMANCES

### VM 350/T

Il ventilatore è orientabile  
The fan is revolvable

Peso ventilatore in kgf 30  
Weight of ventilator in kgf 30

PD<sup>2</sup> = 0,34 kgf m<sup>2</sup>  
GD<sup>2</sup> = 0,34 kgf m<sup>2</sup>

Massima velocità di rotazione  
Maximum rotation speed

<100°C = 5000  
100÷200°C = 4500  
200÷300°C = 4000

Tolleranza sulla rumorosità + 3 dB(A)  
Noise tolerance + 3 dB(A)

Tolleranza sulla potenza assorbita ± 3%  
Absorbed power tolerance ± 3%

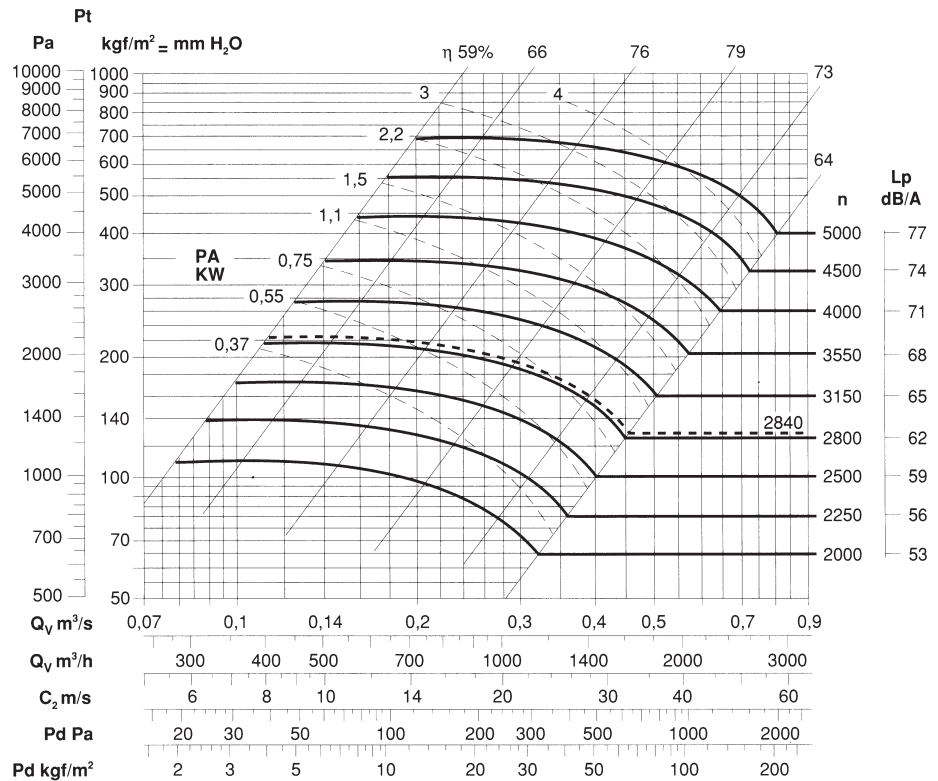

### VM 400/T

Il ventilatore è orientabile  
The fan is revolvable

Peso ventilatore in kgf 54  
Weight of ventilator in kgf 54

PD<sup>2</sup> = 0,7 kgf m<sup>2</sup>  
GD<sup>2</sup> = 0,7 kgf m<sup>2</sup>

Massima velocità di rotazione  
Maximum rotation speed

<100°C = 4750  
100÷200°C = 4250  
200÷300°C = 3750

Tolleranza sulla rumorosità + 3 dB(A)  
Noise tolerance + 3 dB(A)

Tolleranza sulla potenza assorbita ± 3%  
Absorbed power tolerance ± 3%

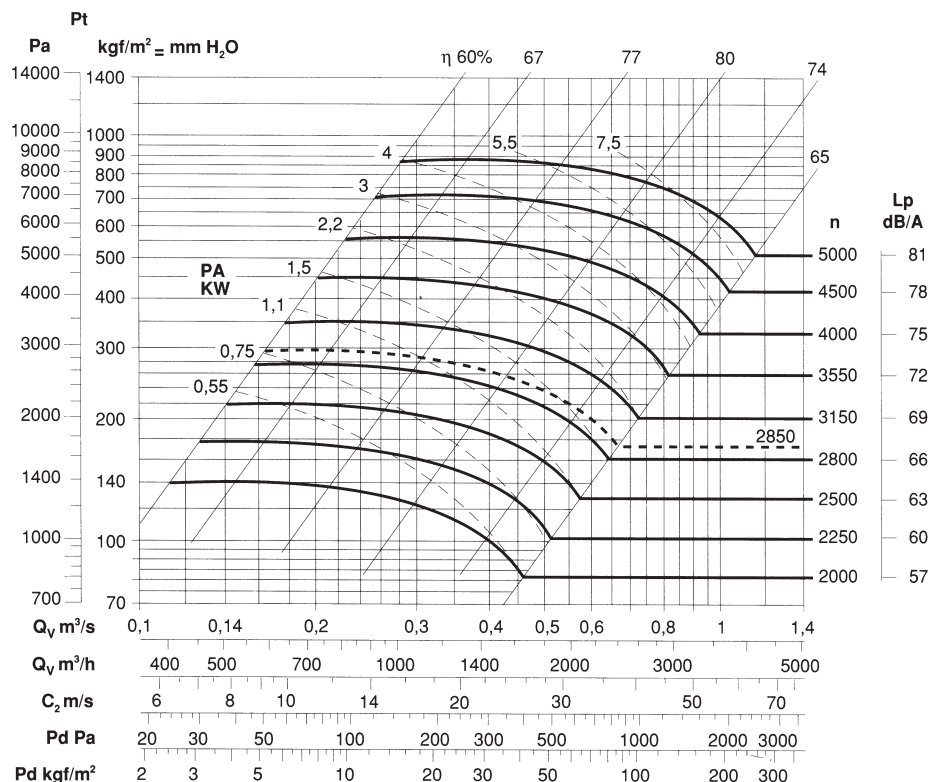

# PRESTAZIONI VENTILATORI A TRASMISSIONE

## BELT DRIVEN FANS PERFORMANCES



### VM 450/T

**Il ventilatore è orientabile**  
The fan is revolvable

**Peso ventilatore in kgf 60**  
Weight of ventilator in kgf 60

**PD<sup>2</sup> = 1,2 kgf m<sup>2</sup>**  
GD<sup>2</sup> = 1,2 kgf m<sup>2</sup>

**Massima velocità di rotazione**  
Maximum rotation speed

- <100°C = 4500
- 100÷200°C = 4000
- 200÷300°C = 3500

**Tolleranza sulla rumorosità + 3 dB(A)**  
Noise tolerance + 3 dB(A)

**Tolleranza sulla potenza assorbita ± 3%**  
Absorbed power tolerance ± 3%

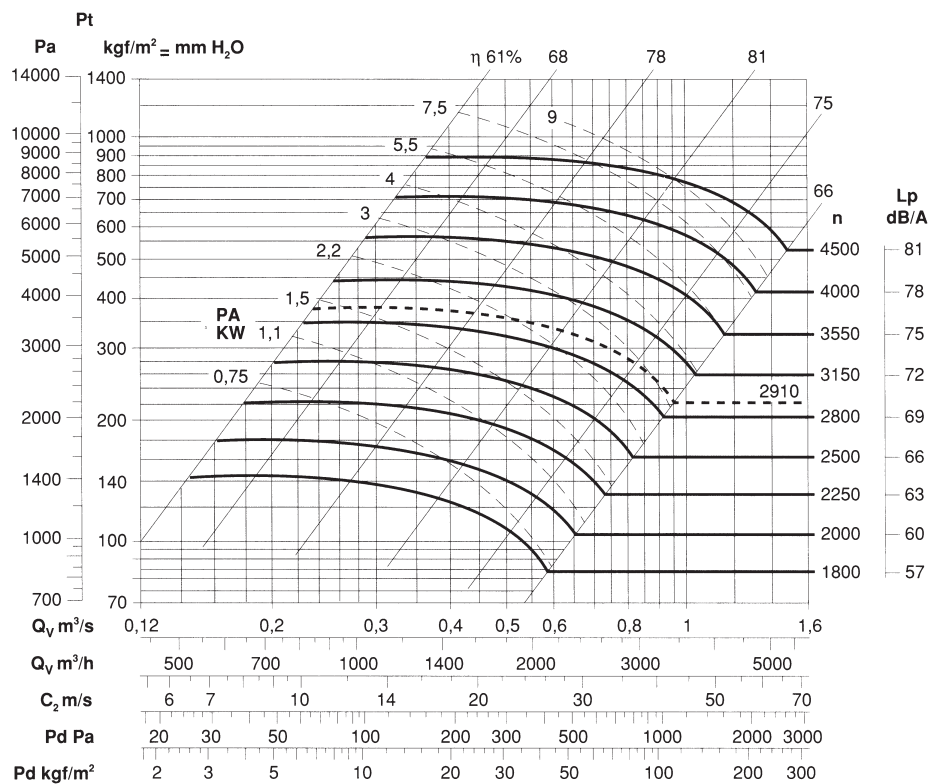

### VM 500/T

**Il ventilatore è orientabile**  
The fan is revolvable

**Peso ventilatore in kgf 82**  
Weight of ventilator in kgf 82

**PD<sup>2</sup> = 1,6 kgf m<sup>2</sup>**  
GD<sup>2</sup> = 1,6 kgf m<sup>2</sup>

**Massima velocità di rotazione**  
Maximum rotation speed

- <100°C = 4250
- 100÷200°C = 3750
- 200÷300°C = 3350

**Tolleranza sulla rumorosità + 3 dB(A)**  
Noise tolerance + 3 dB(A)

**Tolleranza sulla potenza assorbita ± 3%**  
Absorbed power tolerance ± 3%

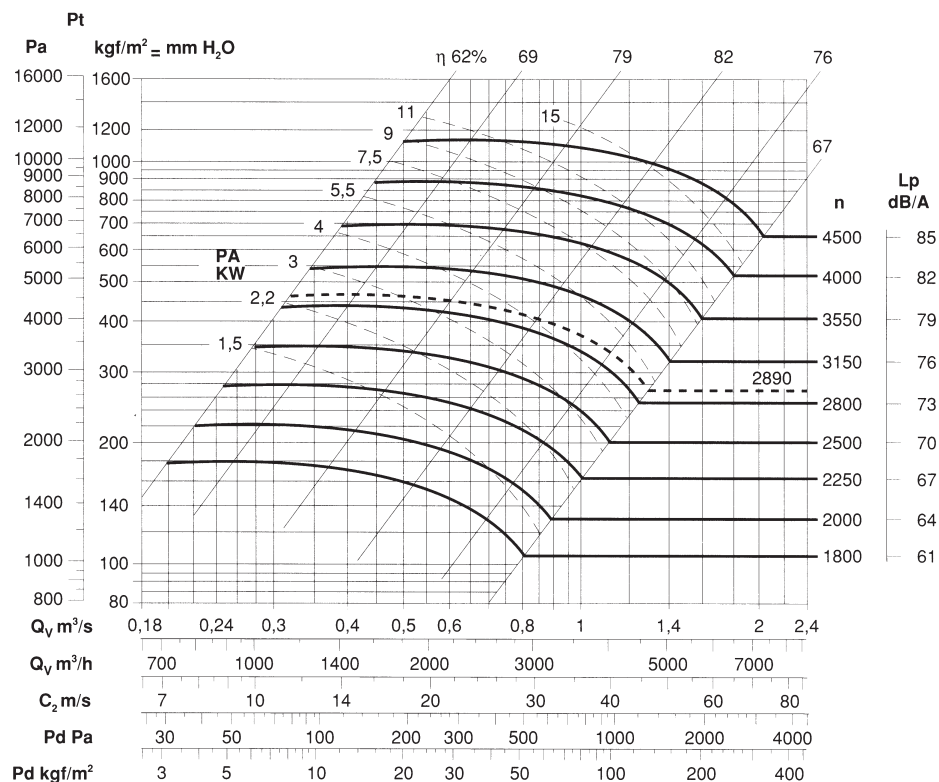



# PRESTAZIONI VENTILATORI A TRASMISSIONE

## BELT DRIVEN FANS PERFORMANCES

### VM 560/T

Il ventilatore è orientabile  
The fan is revolvable

Peso ventilatore in kgf 122  
Weight of ventilator in kgf 122

PD<sup>2</sup> = 2,6 kgf m<sup>2</sup>  
GD<sup>2</sup> = 2,6 kgf m<sup>2</sup>

Massima velocità di rotazione  
Maximum rotation speed

<100°C = 4000  
100÷200°C = 3550  
200÷300°C = 3150

Tolleranza sulla rumorosità + 3 dB(A)  
Noise tolerance + 3 dB(A)

Tolleranza sulla potenza assorbita ± 3%  
Absorbed power tolerance ± 3%

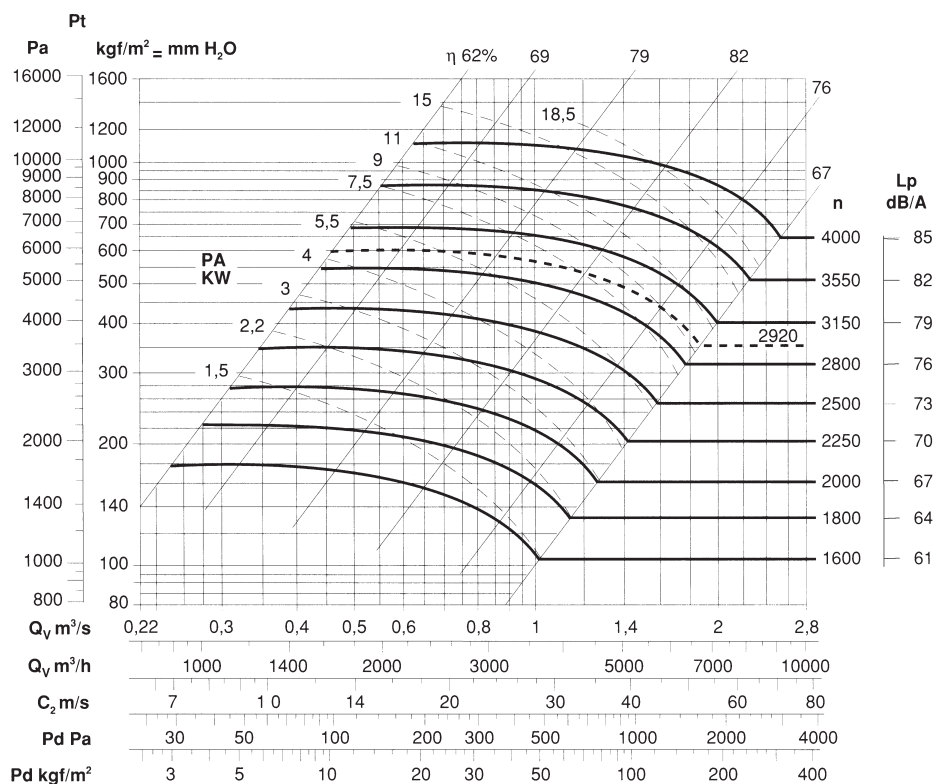

### VM 630/T

Il ventilatore è orientabile  
The fan is revolvable

Peso ventilatore in kgf 173  
Weight of ventilator in kgf 173

PD<sup>2</sup> = 4,1 kgf m<sup>2</sup>  
GD<sup>2</sup> = 4,1 kgf m<sup>2</sup>

Massima velocità di rotazione  
Maximum rotation speed

<100°C = 3750  
100÷200°C = 3350  
200÷300°C = 3000

Tolleranza sulla rumorosità + 3 dB(A)  
Noise tolerance + 3 dB(A)

Tolleranza sulla potenza assorbita ± 3%  
Absorbed power tolerance ± 3%

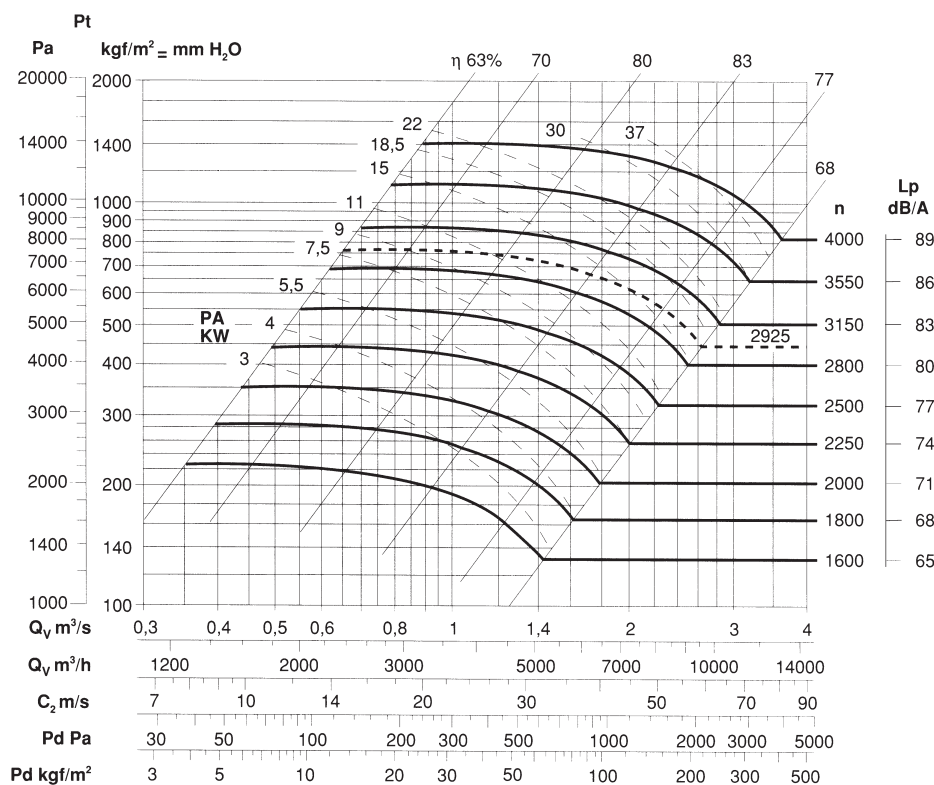

# PRESTAZIONI VENTILATORI A TRASMISSIONE

## BELT DRIVEN FANS PERFORMANCES



### VM 710/T

**Il ventilatore è orientabile**  
The fan is revolvable

**Peso ventilatore in kgf 220**  
Weight of ventilator in kgf 220

**PD<sup>2</sup> = 7,7 kgf m<sup>2</sup>**

**Massima velocità di rotazione**  
Maximum rotation speed

<100°C = 3550  
100÷200°C = 3150  
200÷300°C = 2800

**Tolleranza sulla rumorosità + 3 dB(A)**  
Noise tolerance + 3 dB(A)

**Tolleranza sulla potenza assorbita ± 3%**  
Absorbed power tolerance ± 3%

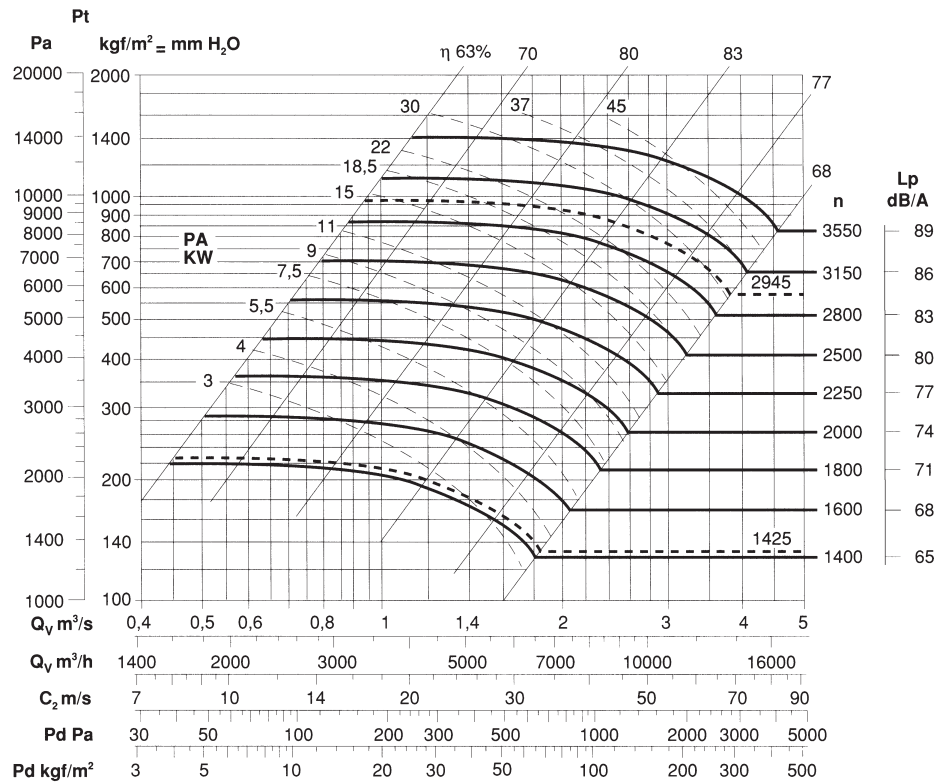

### VM 800/T

**Il ventilatore è orientabile**  
The fan is revolvable

**Peso ventilatore in kgf 290**  
Weight of ventilator in kgf 290

**PD<sup>2</sup> = 13 kgf m<sup>2</sup>**

**Massima velocità di rotazione**  
Maximum rotation speed

<100°C = 3350  
100÷200°C = 3000  
200÷300°C = 2650

**Tolleranza sulla rumorosità + 3 dB(A)**  
Noise tolerance + 3 dB(A)

**Tolleranza sulla potenza assorbita ± 3%**  
Absorbed power tolerance ± 3%

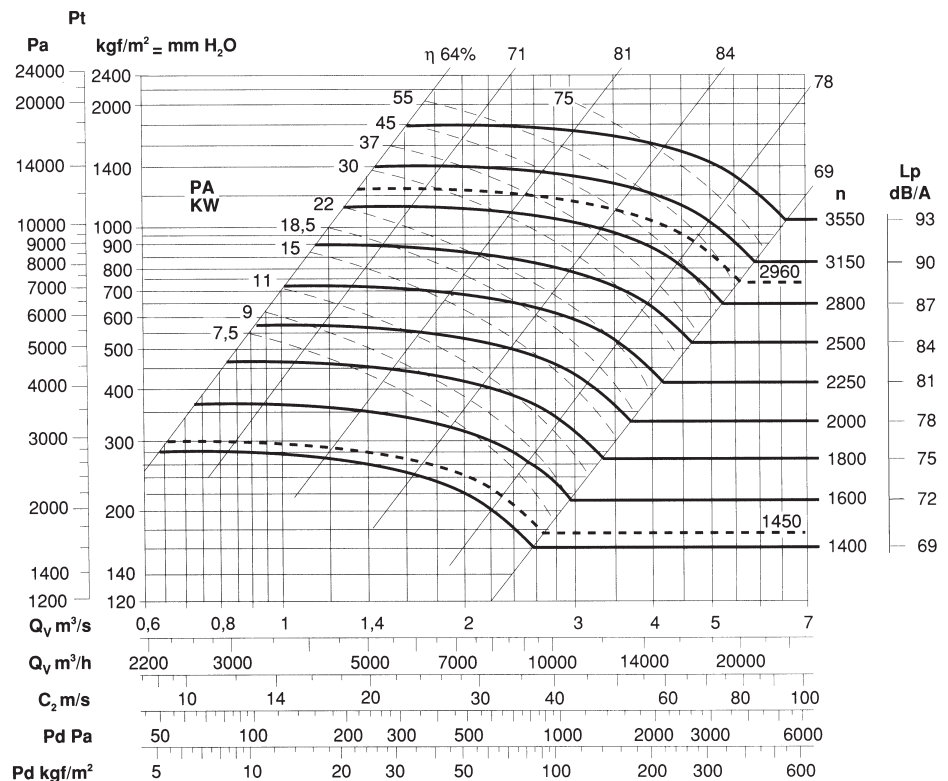



# PRESTAZIONI VENTILATORI A TRASMISSIONE

## BELT DRIVEN FANS PERFORMANCES

### VM 900/T

**Il ventilatore è orientabile**  
The fan is revolvable

**Peso ventilatore in kgf 469**  
Weight of ventilator in kgf 469

**PD<sup>2</sup> = 26 kgf m<sup>2</sup>**  
GD<sup>2</sup> = 26 kgf m<sup>2</sup>

**Massima velocità di rotazione**  
Maximum rotation speed

<100°C = 3150  
100÷200°C = 2800  
200÷300°C = 2500

**Tolleranza sulla rumorosità + 3 dB(A)**  
Noise tolerance + 3 dB(A)

**Tolleranza sulla potenza assorbita ± 3%**  
Absorbed power tolerance ± 3%

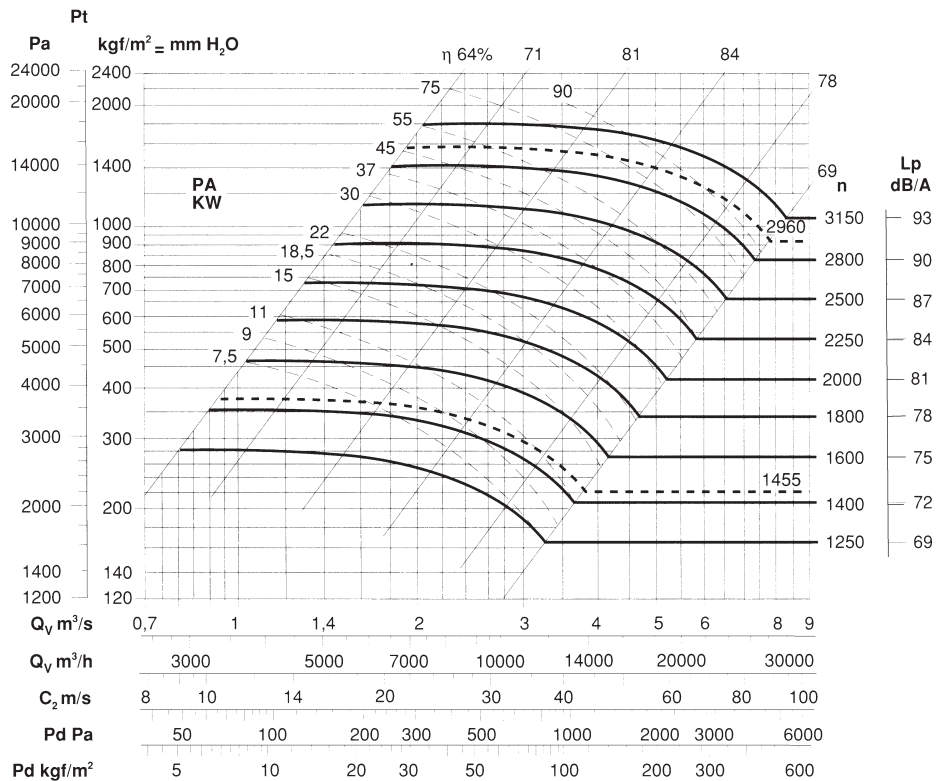

### VM 1000/T

**Il ventilatore è orientabile**  
The fan is revolvable

**Peso ventilatore in kgf 680**  
Weight of ventilator in kgf 680

**PD<sup>2</sup> = 40 kgf m<sup>2</sup>**  
GD<sup>2</sup> = 40 kgf m<sup>2</sup>

**Massima velocità di rotazione**  
Maximum rotation speed

<100°C = 3000  
100÷200°C = 2650  
200÷300°C = 2350

**Tolleranza sulla rumorosità + 3 dB(A)**  
Noise tolerance + 3 dB(A)

**Tolleranza sulla potenza assorbita ± 3%**  
Absorbed power tolerance ± 3%

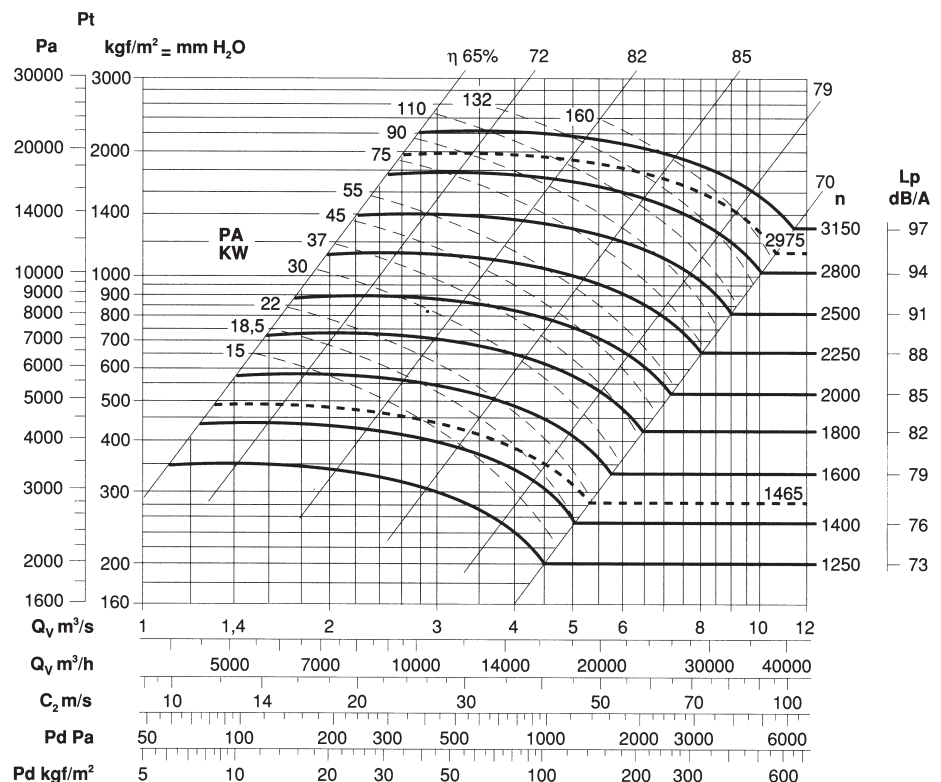

# PRESTAZIONI VENTILATORI A TRASMISSIONE

## BELT DRIVEN FANS PERFORMANCES



### VM 1120/T

**Il ventilatore è orientabile**  
The fan is revolvable

**Peso ventilatore in kgf 710**  
Weight of ventilator in kgf 710

**PD<sup>2</sup> = 61 kgf m<sup>2</sup>**  
GD<sup>2</sup> = 61 kgf m<sup>2</sup>

**Massima velocità di rotazione**  
Maximum rotation speed

<100°C = 2800  
100÷200°C = 2500  
200÷300°C = 2250

**Tolleranza sulla rumorosità + 3 dB(A)**  
Noise tolerance + 3 dB(A)

**Tolleranza sulla potenza assorbita ± 3%**  
Absorbed power tolerance ± 3%

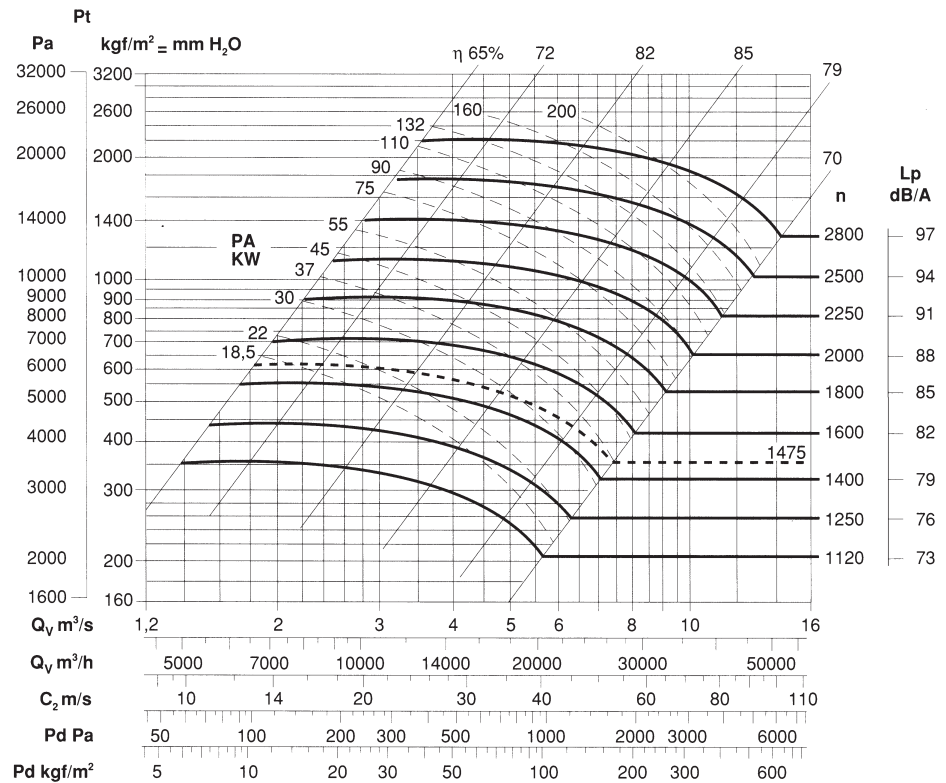

### VM 1250/T

**Il ventilatore è orientabile**  
The fan is revolvable

**Peso ventilatore in kgf 770**  
Weight of ventilator in kgf 770

**PD<sup>2</sup> = 97 kgf m<sup>2</sup>**  
GD<sup>2</sup> = 97 kgf m<sup>2</sup>

**Massima velocità di rotazione**  
Maximum rotation speed

<100°C = 2500  
100÷200°C = 2250  
200÷300°C = 2000

**Tolleranza sulla rumorosità + 3 dB(A)**  
Noise tolerance + 3 dB(A)

**Tolleranza sulla potenza assorbita ± 3%**  
Absorbed power tolerance ± 3%

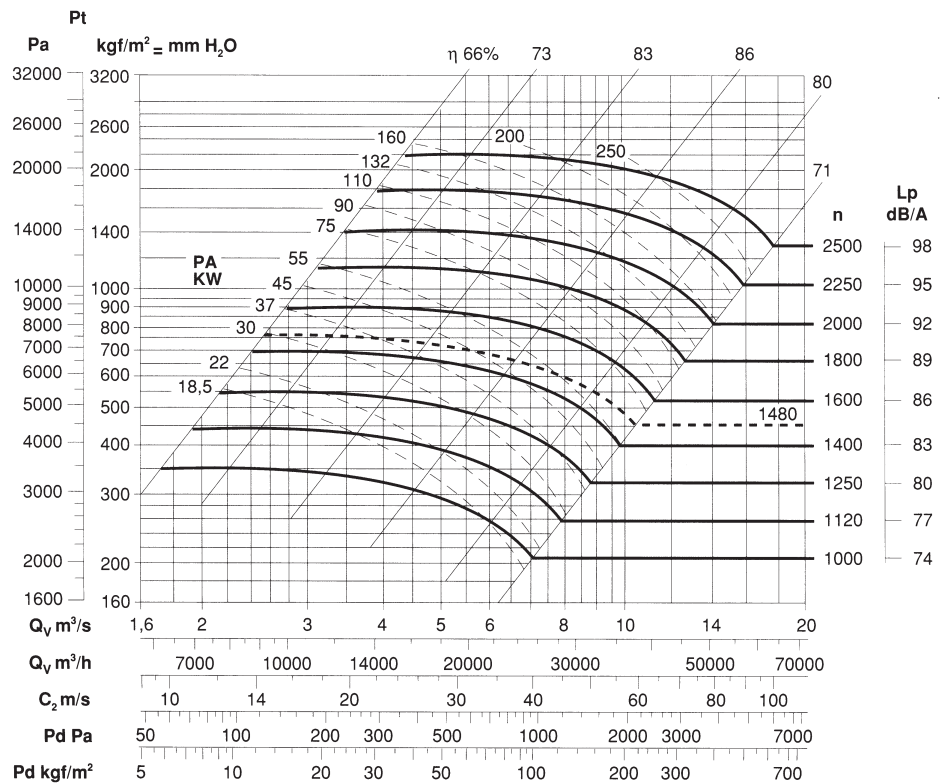



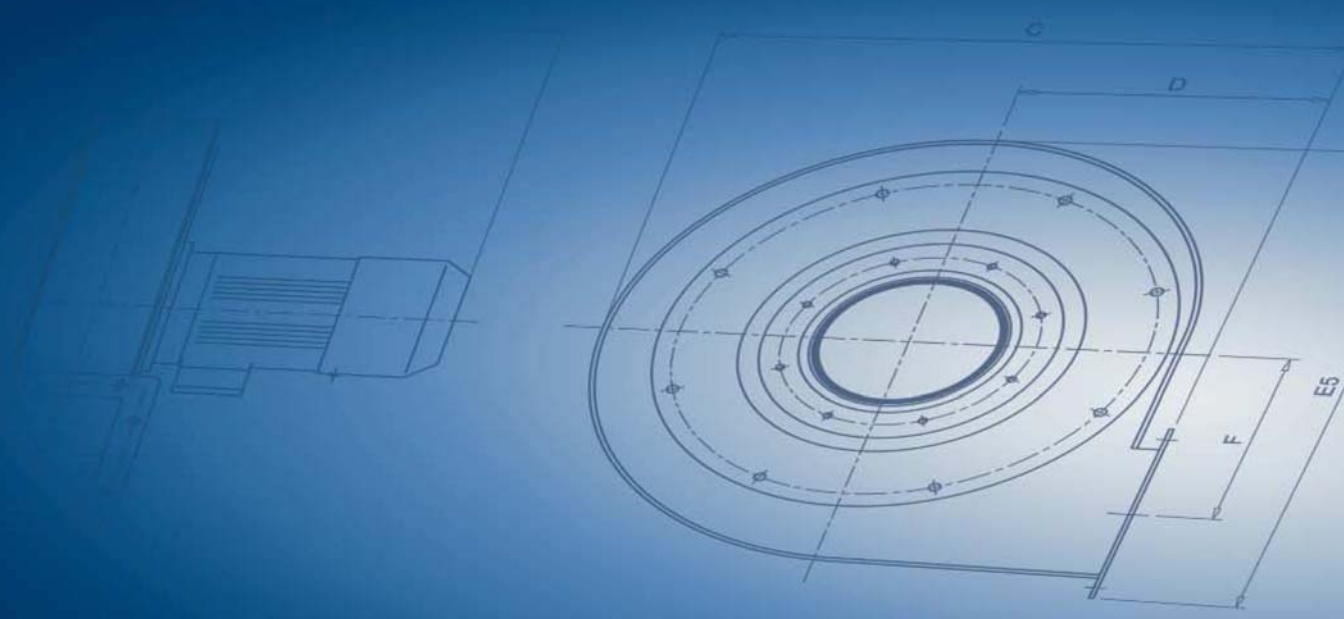

ACF Ventilatoren GmbH | Elf Stücken 21 | 49324 Melle | Tel.: +49(0)5422-9895-0 | Fax +49(0)5422-9895-15  
www.acf-ventilatoren.de | info@acf-ventilatoren.de